

ケース型番 / Product Number

EXS 288 - 78 -

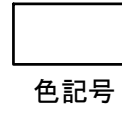
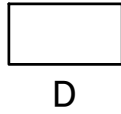

色記号
Color Code

寸法制限範囲 / Dimension limit range

D = 40 ~ 500

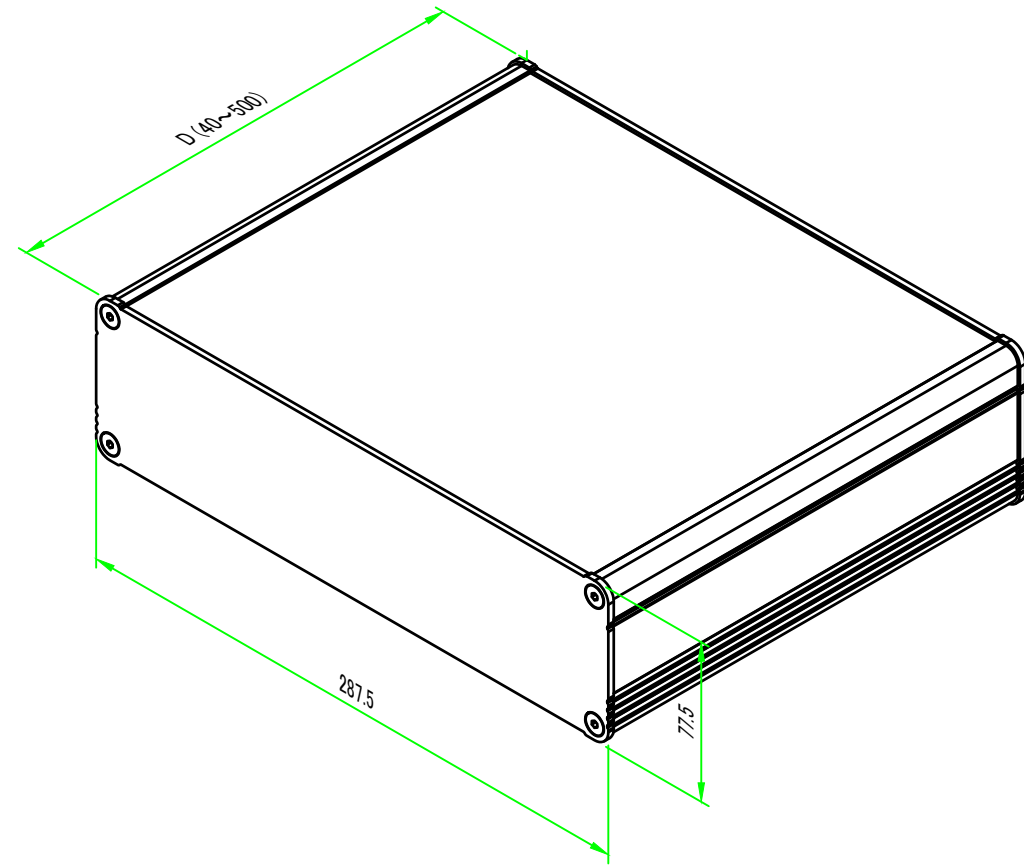

構成内容 / Components				
No.	名称 / Part name	数量 / Pcs	材質 / Material	色・表面処理 / Color・Finish
1	パネル / End panel	2	アルミ板 / Aluminium A1050P	ブラック, シルバー・アルマイト / Black, Silver・anodized
2	上カバー / Top cover	1	アルミ押出材 / Extruded aluminium A6063S-T5	ブラック, シルバー・アルマイト & クリア塗装 / Black, Silver・anodized & clear coated
3	下カバー / Bottom cover	1	アルミ押出材 / Extruded aluminium A6063S-T5	ブラック, シルバー・アルマイト & クリア塗装 / Black, Silver・anodized & clear coated
4	取付ビス(六角穴付皿 M5×10) / Screw	8	ステンレス / Stainless steel	無処理 / Unfinished
5	ゴム足 / Rubber feet	4	合成ゴム / Rubber	ブラック / Black

※ゴム足は任意の場所に貼り付けできます。

※Adhesive rubber feet included.

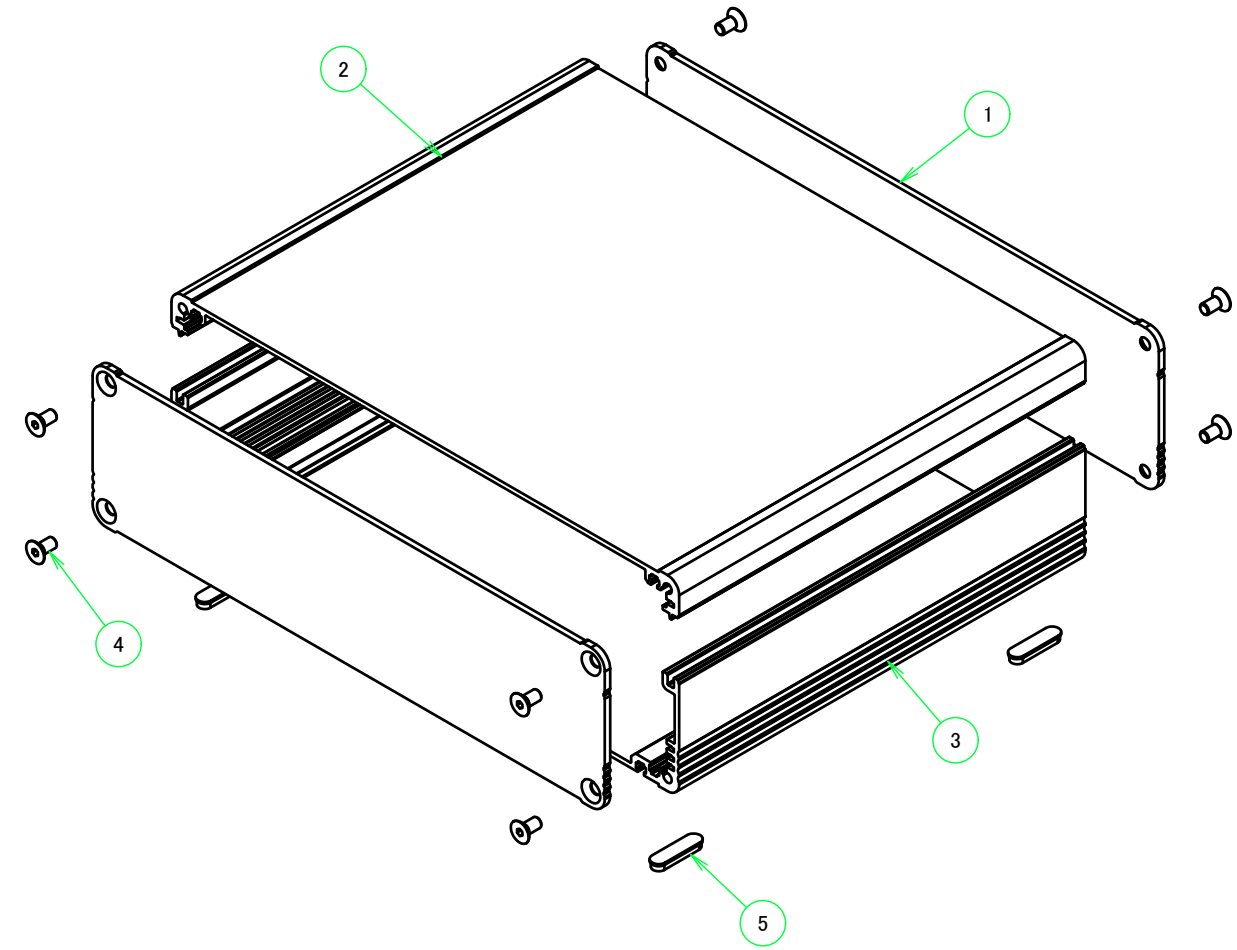

色仕様(型番末尾口) / Color type

記号 / Code	上下カバー / Cover	パネル / Panel
SS	シルバー / Silver	シルバー / Silver
SB	シルバー / Silver	ブラック / Black
BS	ブラック / Black	シルバー / Silver
BB	ブラック / Black	ブラック / Black

株式会社タカチ電機工業 <small>TAKACHI ELECTRONICS ENCLOSURE CO., LTD.</small>			品名 / Title アルミ押出材フリーサイズケース EXTRUDED ALUMINIUM CASE -CUSTOM LENGTH-	尺度 / Scale 1 : 3
承認 / Approved	検図 / Checked	製図 / Created	型番 / Product number EXS288-78-□□□	
中根	大江	岡本	作成日 / Date 2022/10/14	1 / 5

ゴム足

Rubber feet

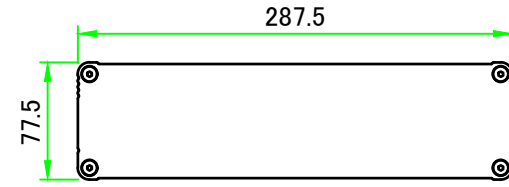
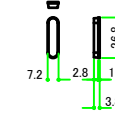

B-B (1:5)

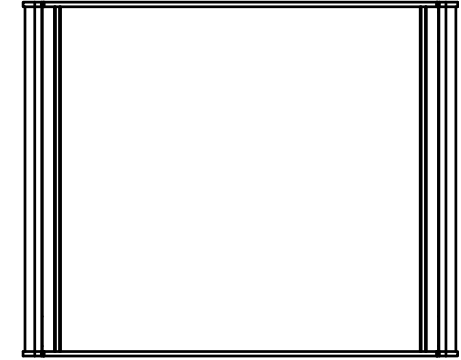
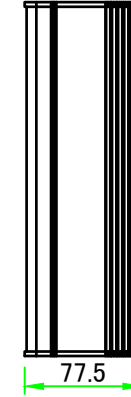
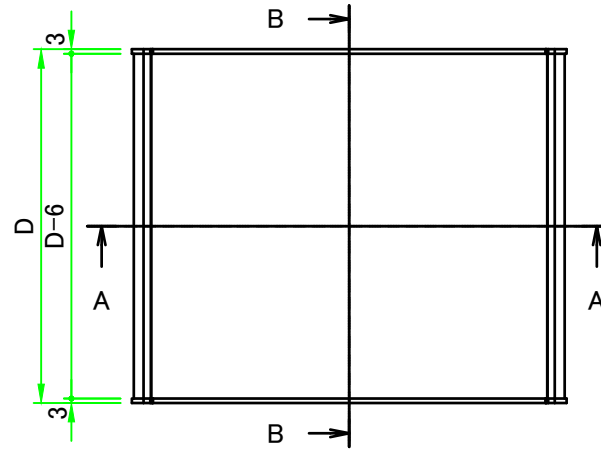
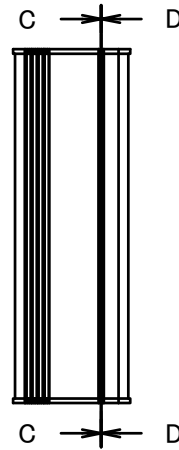
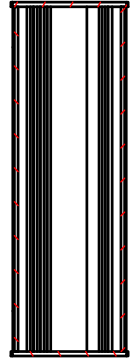

C-C (1:5)

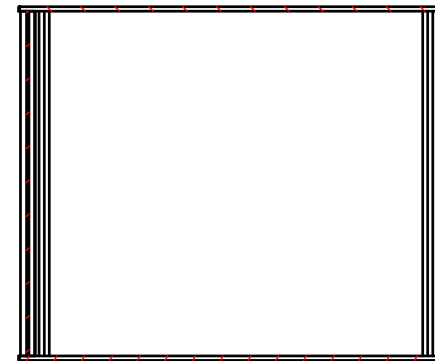

D-D (1:5)

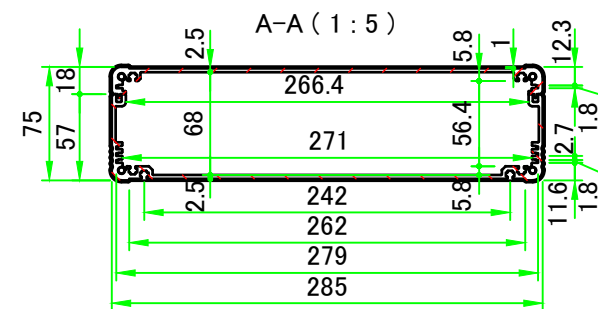
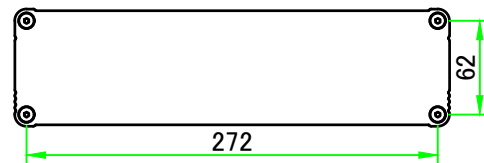
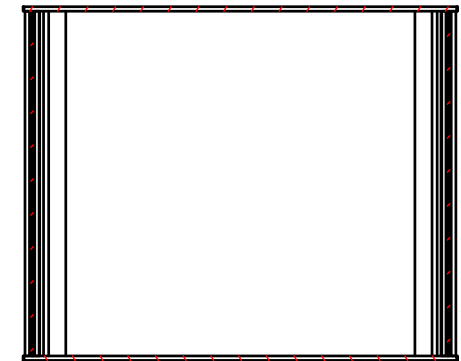

株式会社タカチ電機工業 TAKACHI ELECTRONICS ENCLOSURE CO., LTD.			品名/Title アルミ押出材フリーサイズケース EXTRUDED ALUMINIUM CASE -CUSTOM LENGTH-	尺度/Scale 1:5
承認/Approved	検図/Checked	製図/Created	型番/Product number EXS288-78-□□□	
中根	大江	岡本	作成日/Date 2022/10/14	2 / 5

上カバー / Top cover

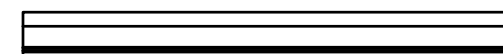
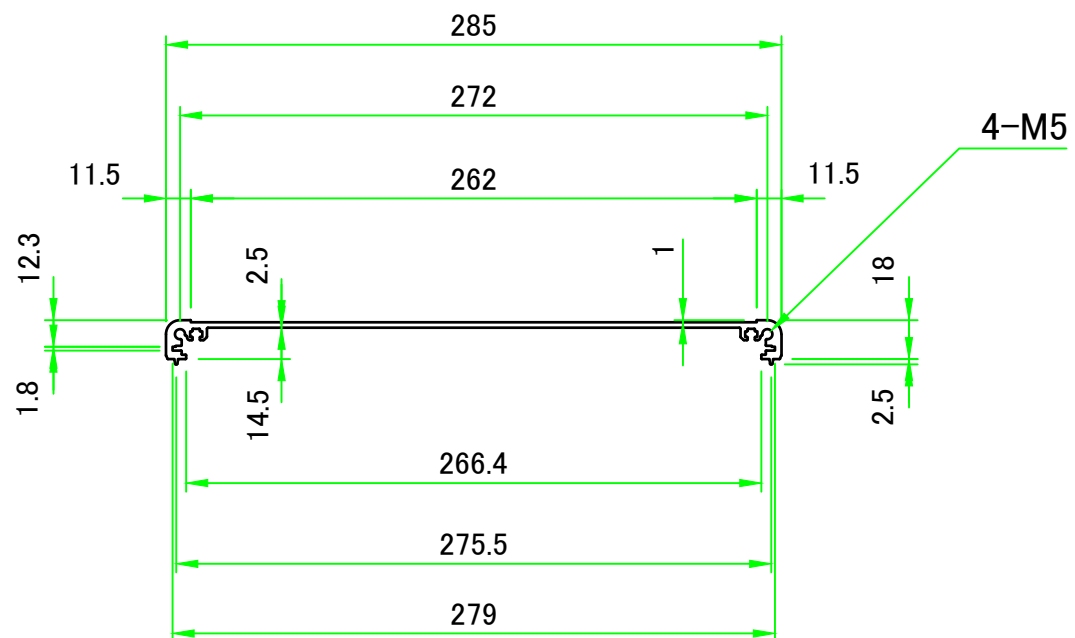
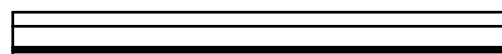
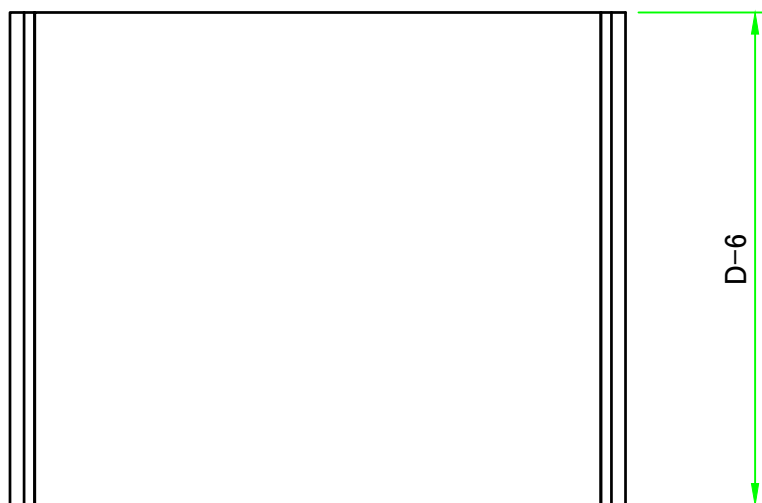

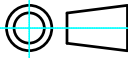
 株式会社タカチ電機工業 TAKACHI ELECTRONICS ENCLOSURE CO., LTD.			品名/Title 上カバー TOP COVER	 尺度/Scale 1: 3.5
承認/Approved 中根	検図/Checked 岡本	製図/Created 大江	型番/Product number W285-D	
			作成日/Date 2022/10/14	3 / 5

下カバー / Bottom cover

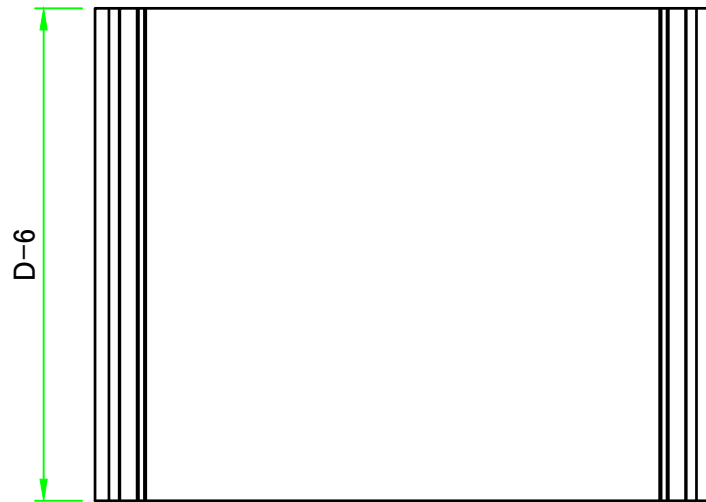
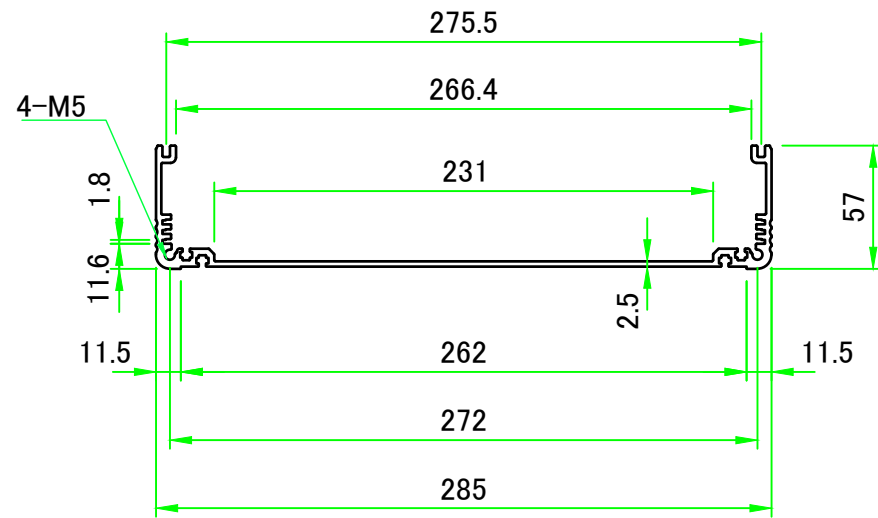
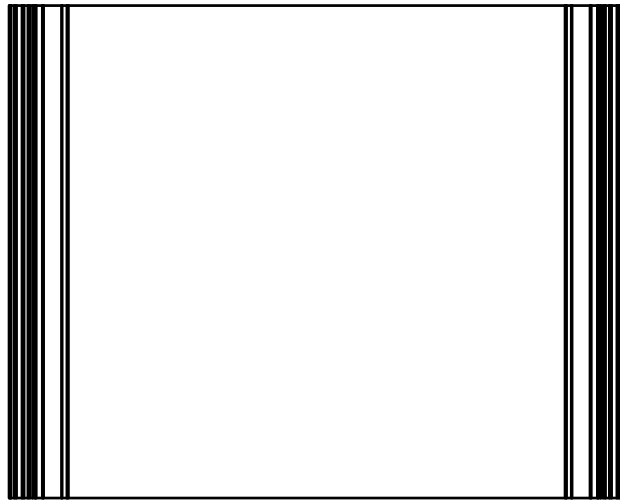

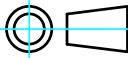
 株式会社タカチ電機工業 TAKACHI ELECTRONICS ENCLOSURE CO., LTD.			品名/Title 下カバー BOTTOM COVER	 尺度/Scale 1:3.5
承認/Approved	検図/Checked	製図/Created	型番/Product number W285-H75-D	
中根	岡本	大江	作成日/Date 2022/10/14	4 / 5

パネル / End panel

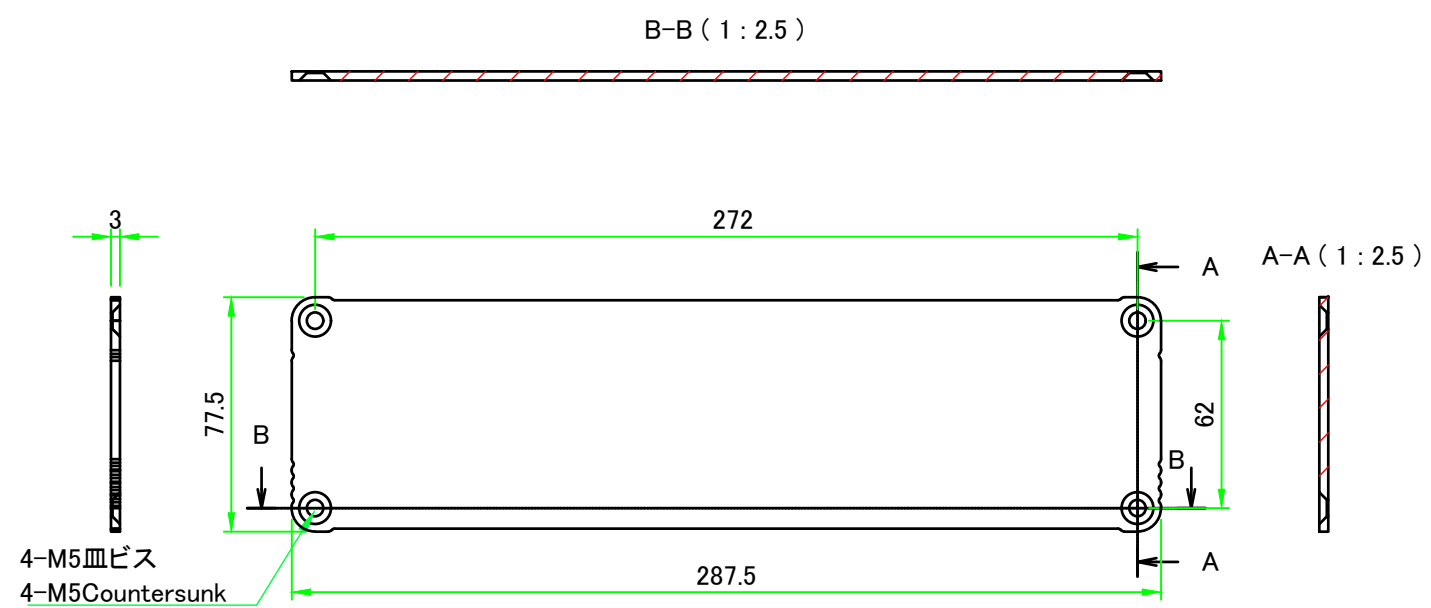

表面 / Outside

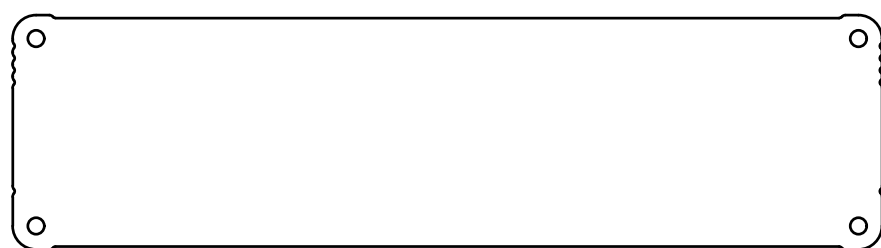

裏面 / Inside

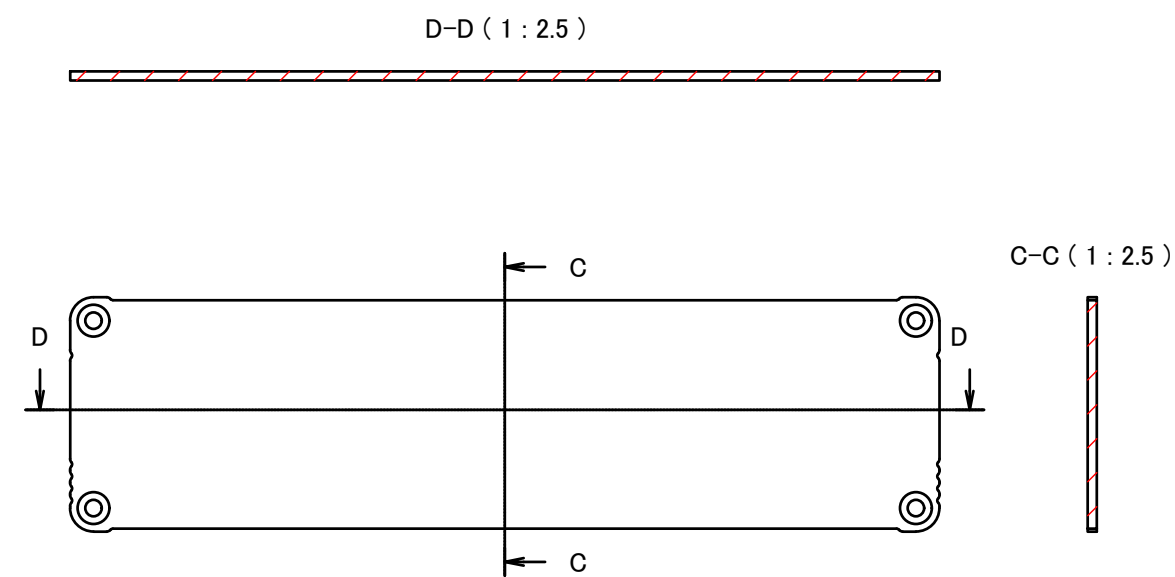

表面 / Outside

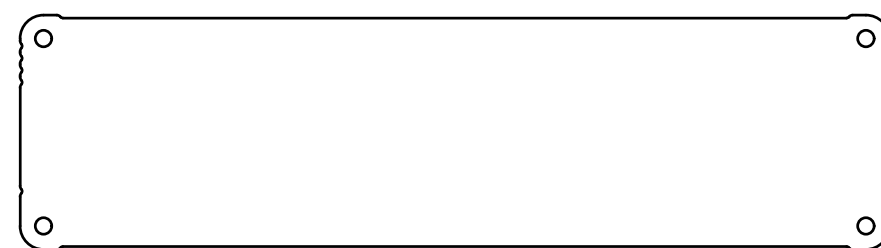

裏面 / Inside

株式会社タカチ電機工業 TAKACHI ELECTRONICS ENCLOSURE CO., LTD.			品名/Title アルミパネル END PANEL	尺度/Scale 1 : 2.5
承認/Approved	検図/Checked	製図/Created	型番/Product number W285-H75	
中根	大江	岡本	作成日/Date 2022/10/14	5 / 5